



www.adosa.es



- DIRECTIVA DE COMPATIBILIDAD ELECTROMAGNÉTICA 89/336/CEE
- DIRECTIVA DE BAJA TENSIÓN 73/23/CEE
- NORMA DE SEGURIDAD PARA SISTEMAS DE TRANSMISIONES HIDRÁULICAS EN 982

PILONAS ESCAMOTEABLES 2024

Su protección en manos de profesionales.

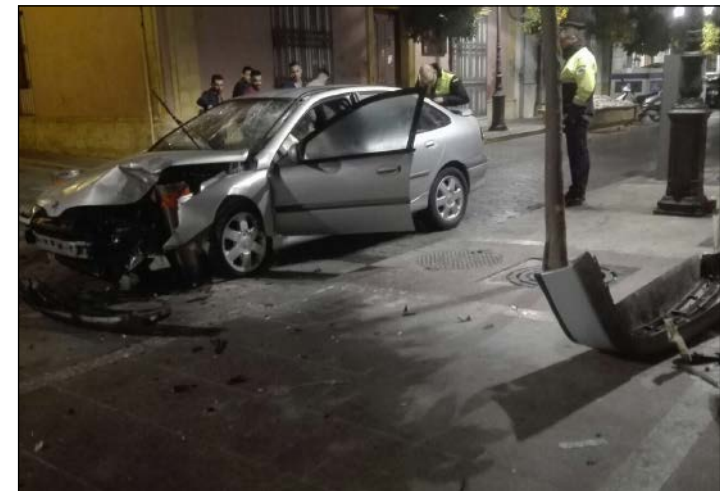

FABRICANTES DE PILONAS

Como empresa pionera en la fabricación de pilonas escamoteables, disponemos de uno de los catálogos más amplios del mercado satisfaciendo las necesidades de los clientes.

Ofrecemos pilonas de calidad a precios competitivos, minimizando costes sin reducir la calidad.

Disponemos desde gamas económicas a pilonas de alta gama de seguridad, también personalizamos pilonas para instalaciones de otras marcas, evitando así los costosos trabajos de albañilería de sustitución de estas.

La experiencia adquirida en todos estos años, nos permite desarrollar todo tipo de soluciones para nuestros clientes.



SYDNEY (GAMA ALTA)

ACERO INOXIDABLE



PEASY220X500

Espesor:
8,5 mm. Ø 114 mm.
8 mm. Ø 220 mm.

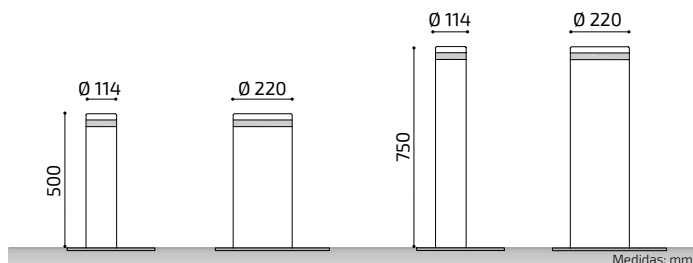

Instalación:



■ Bajo pedido AISI 316.



MELBOURNE (GAMA ALTA)

HIERRO GALVANIZADO



PEAME220X500

Espesor:
10 mm. Ø 114 mm.
10 mm. Ø 220 mm.

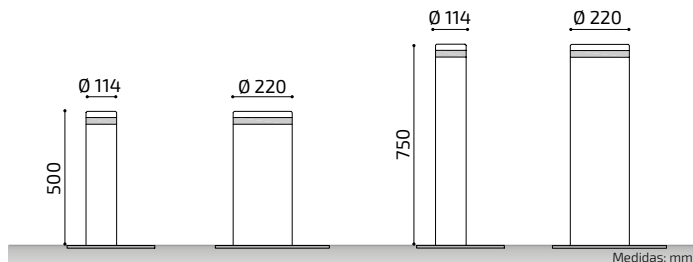

Instalación:



OSLO (GAMA MEDIA)

ACERO INOXIDABLE



PEASY220X500

Espesor:
 3 mm. Ø 114 mm.
 3,7 mm. Ø 220 mm.

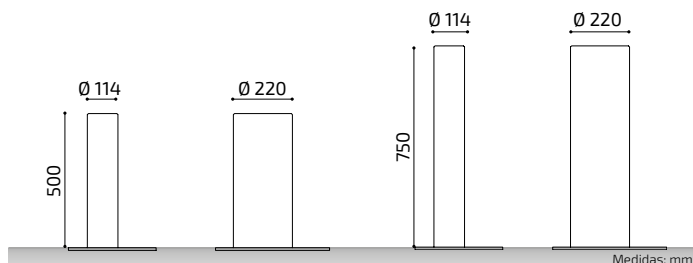

Medidas: mm.

Instalación:

Chasis. + Cajón perdido. | Cinta reflectante opcional.

■ Bajo pedido AISI 316.



ESTOCOLMO (GAMA MEDIA)

HIERRO GALVANIZADO



PEAME220X500

Espesor:
 4 mm. Ø 114 mm.
 5 mm. Ø 220 mm.

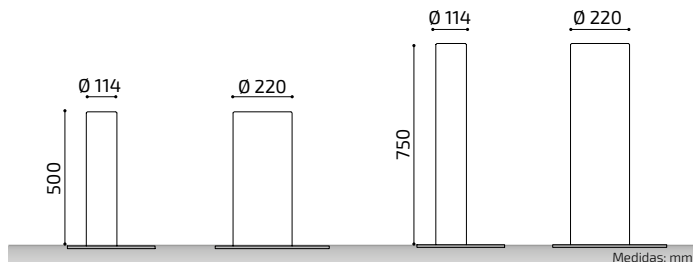

Medidas: mm.

Instalación:

Chasis. + Cajón perdido.



LUXEMBURGO (GAMA ALTA)

ACERO INOXIDABLE



PEMLU220X500

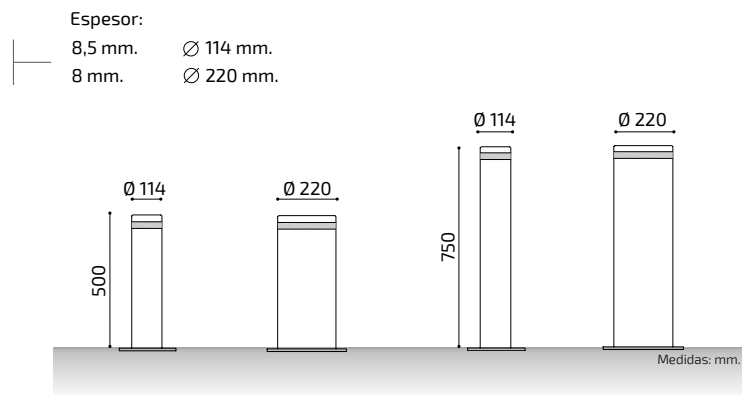

Instalación:



■ Bajo pedido AISI 316.



BRUSELAS (GAMA ALTA)

HIERRO GALVANIZADO



PEMBR220X500

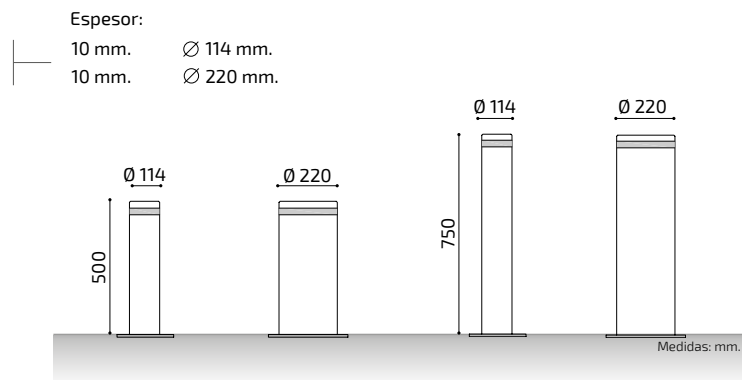

Instalación:



CHELSEA (GAMA ECONÓMICA)

ACERO INOXIDABLE



PEMCH114X500

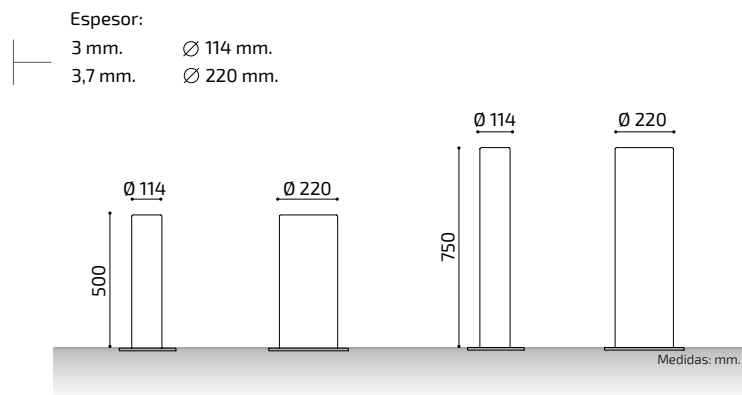

Instalación:

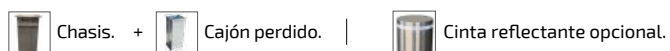

■ Bajo pedido AISI 316.



LONDON (GAMA ECONÓMICA)

HIERRO GALVANIZADO

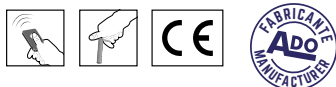

PEMLOS220X500

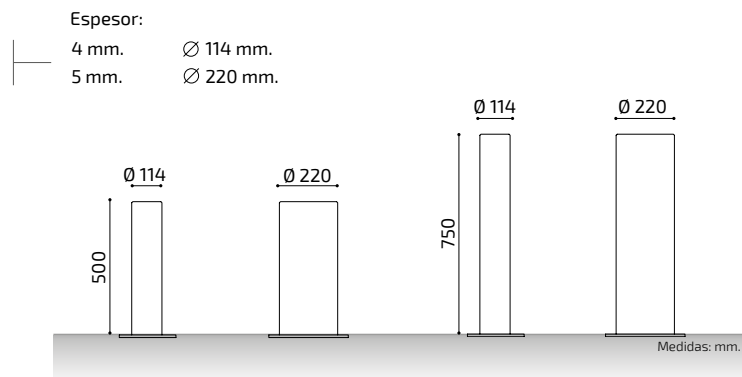

Instalación:

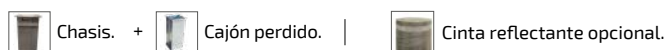

BUENOS AIRES (GAMA ALTA)

ACERO INOXIDABLE



PEMBU220X500

Espesor:
8,5 mm. Ø 114 mm.
8 mm. Ø 220 mm.

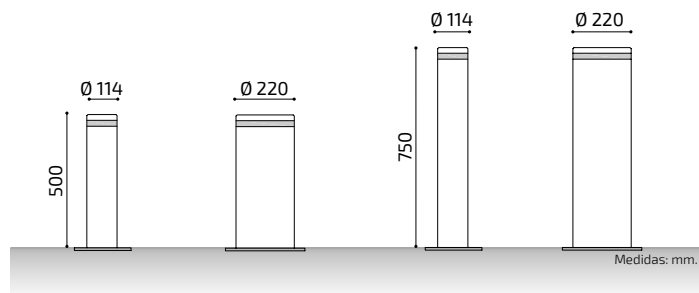

Instalación:



Chasis / Cajón perdido.

■ Bajo pedido AISI 316.

ROSARIO (GAMA ALTA)

HIERRO GALVANIZADO



PEMRO220X500

Espesor:
10 mm. Ø 114 mm.
10 mm. Ø 220 mm.

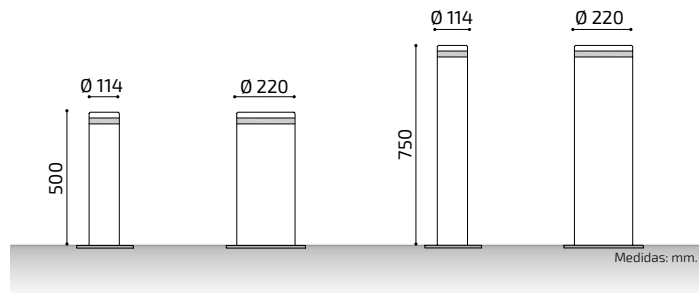

Instalación:



Chasis / Cajón perdido.

RIO (GAMA MEDIA)

ACERO INOXIDABLE



PEMRI220X500

Espesor:
 3 mm. Ø 114 mm.
 3,7 mm. Ø 220 mm.

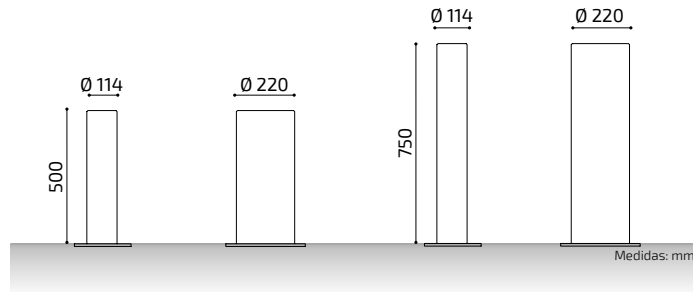

Instalación:



Chasis / Cajón perdido.



Cinta reflectante opcional.

■ Bajo pedido AISI 316.

BRASILIA (GAMA MEDIA)

HIERRO GALVANIZADO



PEMBRA220X500

Espesor:
 4 mm. Ø 114 mm.
 5 mm. Ø 220 mm.

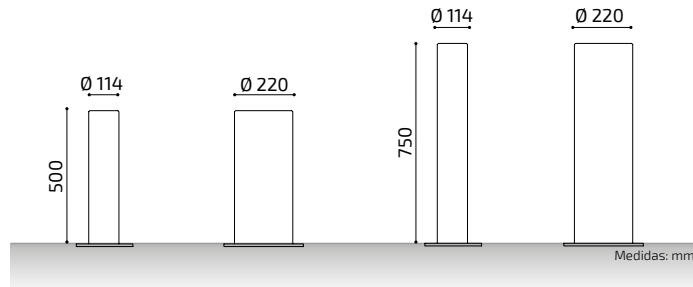

Instalación:



Chasis / Cajón perdido.



Cinta reflectante opcional.

ABU DABI (GAMA ALTA)

ACERO INOXIDABLE

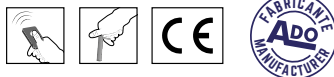

PEAB220X500

Espesor:
8,5 mm. Ø 114 mm.
8 mm. Ø 220 mm.

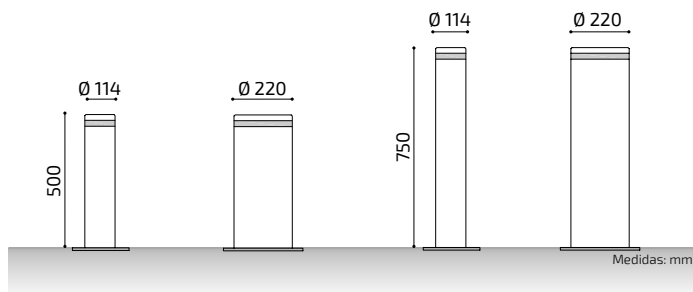

Instalación:



Chasis / Cajón perdido.

■ Bajo pedido AISI 316.

DUBAI (GAMA ALTA)

HIERRO GALVANIZADO

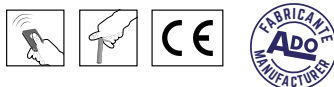

PEADU220X500

Espesor:
10 mm. Ø 114 mm.
10 mm. Ø 220 mm.

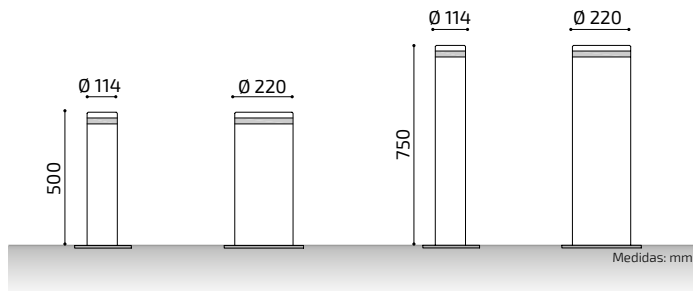

Instalación:



Chasis / Cajón perdido.

TORONTO (GAMA ECONÓMICA)

ACERO INOXIDABLE



PEATO220X500

Espesor:

3 mm. Ø 114 mm.
3,7 mm. Ø 220 mm.

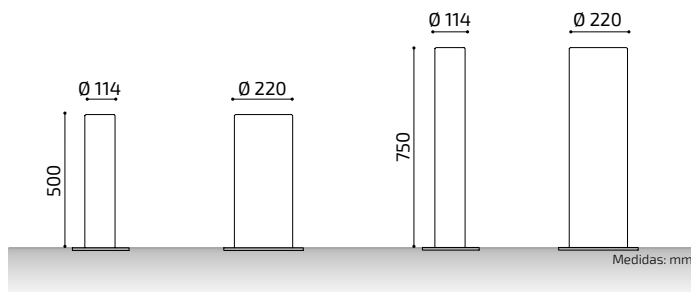

Instalación:



Chasis / Cajón perdido.



Cinta reflectante opcional.

■ Bajo pedido AISI 316.

MONTREAL (GAMA ECONÓMICA)

HIERRO GALVANIZADO

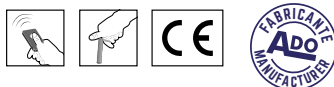

PEAMO220X500

Espesor:

4 mm. Ø 114 mm.
5 mm. Ø 220 mm.

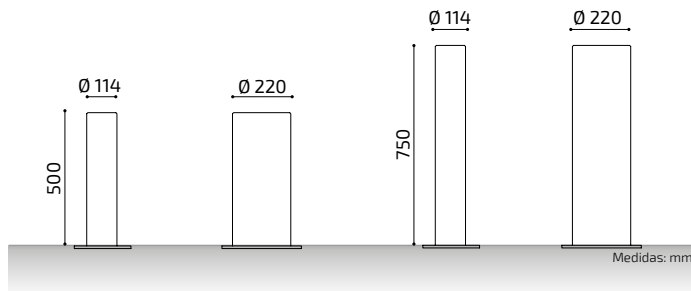

Instalación:



Chasis / Cajón perdido.



Cinta reflectante opcional.

CANCUN (GAMA MEDIA)

ACERO INOXIDABLE



PEMCA140X500

Espesor:
 3 mm. Ø 114 mm.
 3,4 mm. Ø 140 mm.
 3,7 mm. Ø 220 mm.

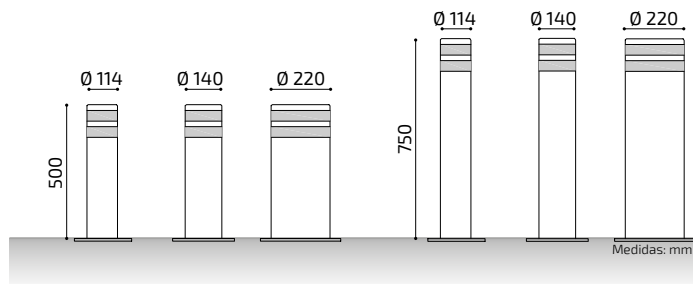

Instalación:



Chasis / Cajón perdido.

■ Bajo pedido AISI 316.

TIJUANA (GAMA MEDIA)

HIERRO GALVANIZADO



PEMMO140X500

Espesor:
 4 mm. Ø 114 mm.
 4 mm. Ø 140 mm.
 5 mm. Ø 220 mm.

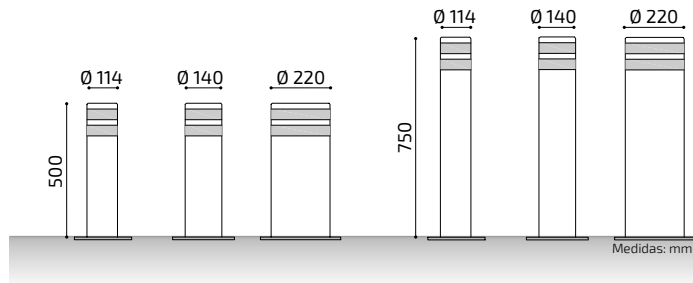

Instalación:



Chasis / Cajón perdido.

NEW YORK (GAMA ALTA)

ACERO INOXIDABLE



PEANE273X750

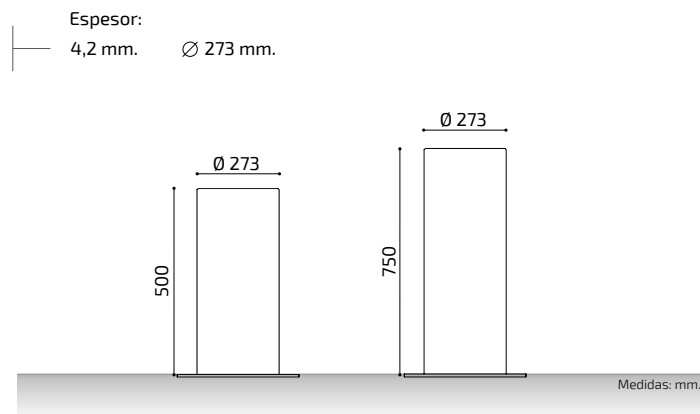

Instalación:



■ Bajo pedido AISI 316.



WASHINGTON (GAMA ALTA)

HIERRO GALVANIZADO

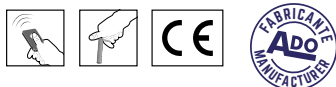

PEAWA273X750

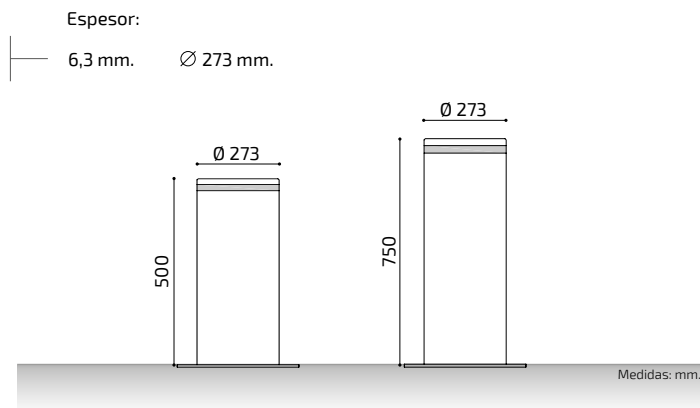

Instalación:



+ ACCESORIOS PILONAS ESCAMOTEABLES

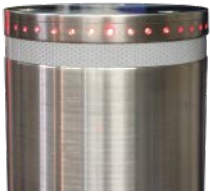

Corona luminosa CILPE.



Corona luminosa CILRA.



Corona luminosa CILMU.



Acero corten.

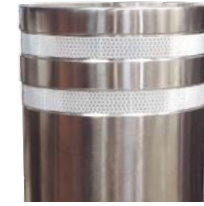

Fresado extra.



Personalización logo.



Pilona fija a juego.



Pilona gradiente.



Diseños especiales.



Cajón perdido.

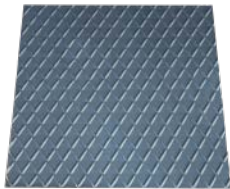

Tapa provisional obra.



Micros posición.



Detección apertura-tapa.



Lazo magnético.



Kit de conexión.



Señal tráfico.



Semáforos.



Calefacción.



Reloj programable pilona automática.



Alarma manipulado pilona.

+ SISTEMAS DE APERTURA



Mandos a distancia.



Tarjetas apertura.



Sistema TAG.



Llavín.



Botonera.



Interfono GSM.

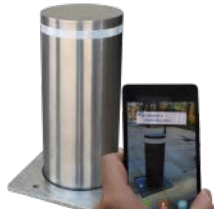

Sistema GSM.



Lector de matrículas.



Código de barras.

+ SISTEMAS DE APERTURA PARA VEHÍCULOS DE EMERGENCIA

Detector sonido (identifica la señal de las sirenas homologadas, ambulancias, policias, bomberos,...) y baja las pilonas para permitir el paso de los vehículos de emergencias sin detenerse.





Postes de control en acero inoxidable con semáforo de leds con posibilidad de añadir accesorios en su interior como lectores de matrículas, teclados numéricos, lectores de tarjetas...

URBAN

ACERO INOXIDABLE



PCACCES02



Opcional protector semáforo

Otras medidas a consultar.
Bajo pedido AISI 316.

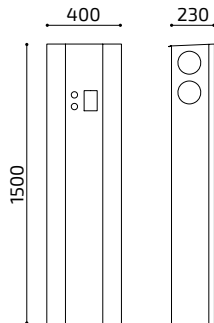

Medidas: mm.

METROPOLIS

STAINLESS STEEL



PCACCES04

Otras medidas a consultar.
Bajo pedido AISI 316.

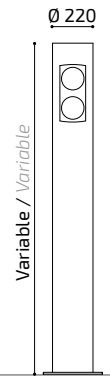

Medidas: mm.



+ ADAPTACIÓN PILONAS ESCAMOTEABLES

Adaptación de nuestras pilonas escamoteables a cajones perdidos y/o chasis ya instalados, de otros fabricantes. Permitiendo la sustitución del vástago y otros componentes sin tener que realizar trabajos de albañilería.

Fabricación de pilona y componentes a la medida que requiera el cliente, adaptando los elementos existentes.





EL CORTE INGLÉS

**INSTALACIONES
PILONAS ESCAMOTEABLES**





FC BARCELONA





FC BARCELONA





AT. DE MADRID





BARCELONA





*SANTA COLOMA
DE GRAMENET*





BARCELONA





Oficines
CORNELLA
i Serveis Tècnics





CALELLA





BARCELONA





BARCELONA

TOUS

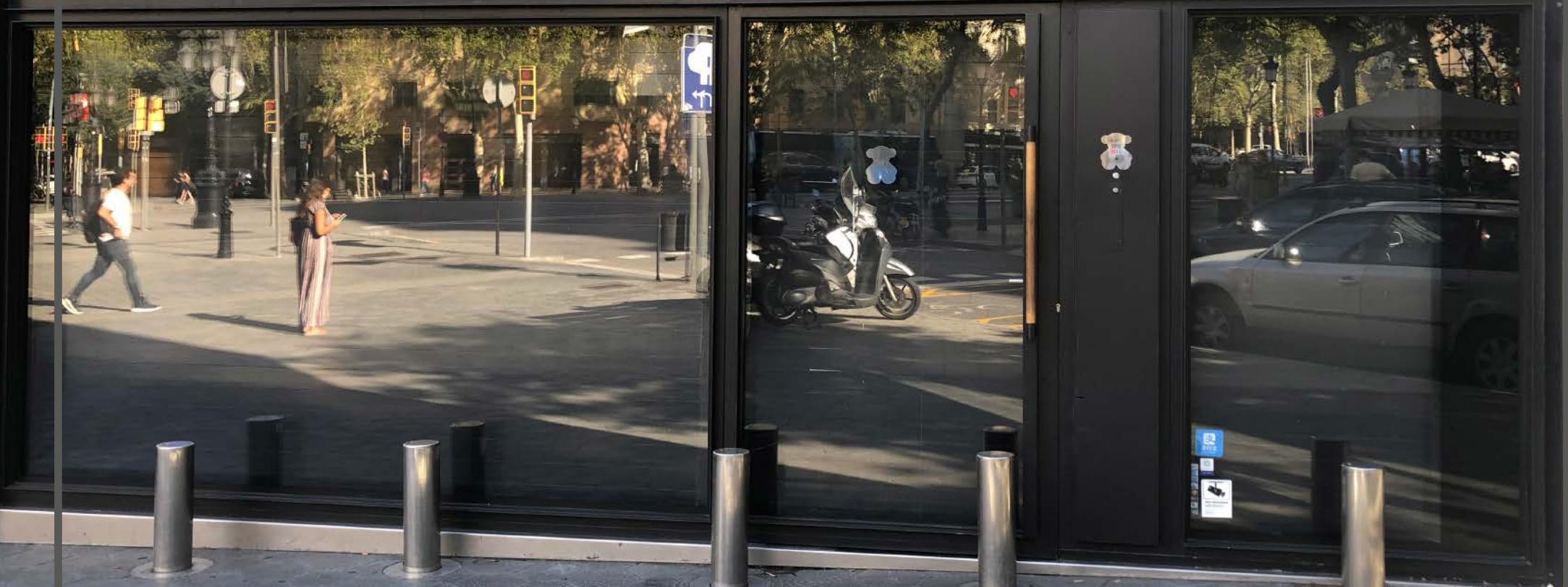



BARCELONA

RABAT
BOUTIQUE

RABAT
BOUTIQUE

RABAT
BOUTIQUE

RABAT RABAT

RABAT

RABAT RABAT

AUDIE
ERLOT



GRAU
BARCELONA



BARCELONA

PHILIPP PLEIN





BARCELONA





LES FONTS





BARCELONA





*SANT FELIU
DE GUIXOLS*





BADALONA





MADRID

RABAT





PRATS DE LLUÇANES





MONTGAT





HELLY HANSEN *BARCELONA*

The store window display features a mannequin dressed in Helly Hansen ultratrail gear, including a red helmet, a grey jacket, a bright yellow-green t-shirt, and orange trail shoes. The mannequin is posed as if running. To the left of the mannequin is a large vertical poster for the 'HELLY HANSEN ULTRATRAIL COLLSEROLA' race. The poster includes a map of the Collserola area, the date '22 NOV 2014', and distances of '23 km', '45 km', and '80 km'. The background of the window shows a white car parked on a street. The entire display is set within a red frame.





BARCELONA

Dior





BARCELONA





OPERA GALLERY

MADRID

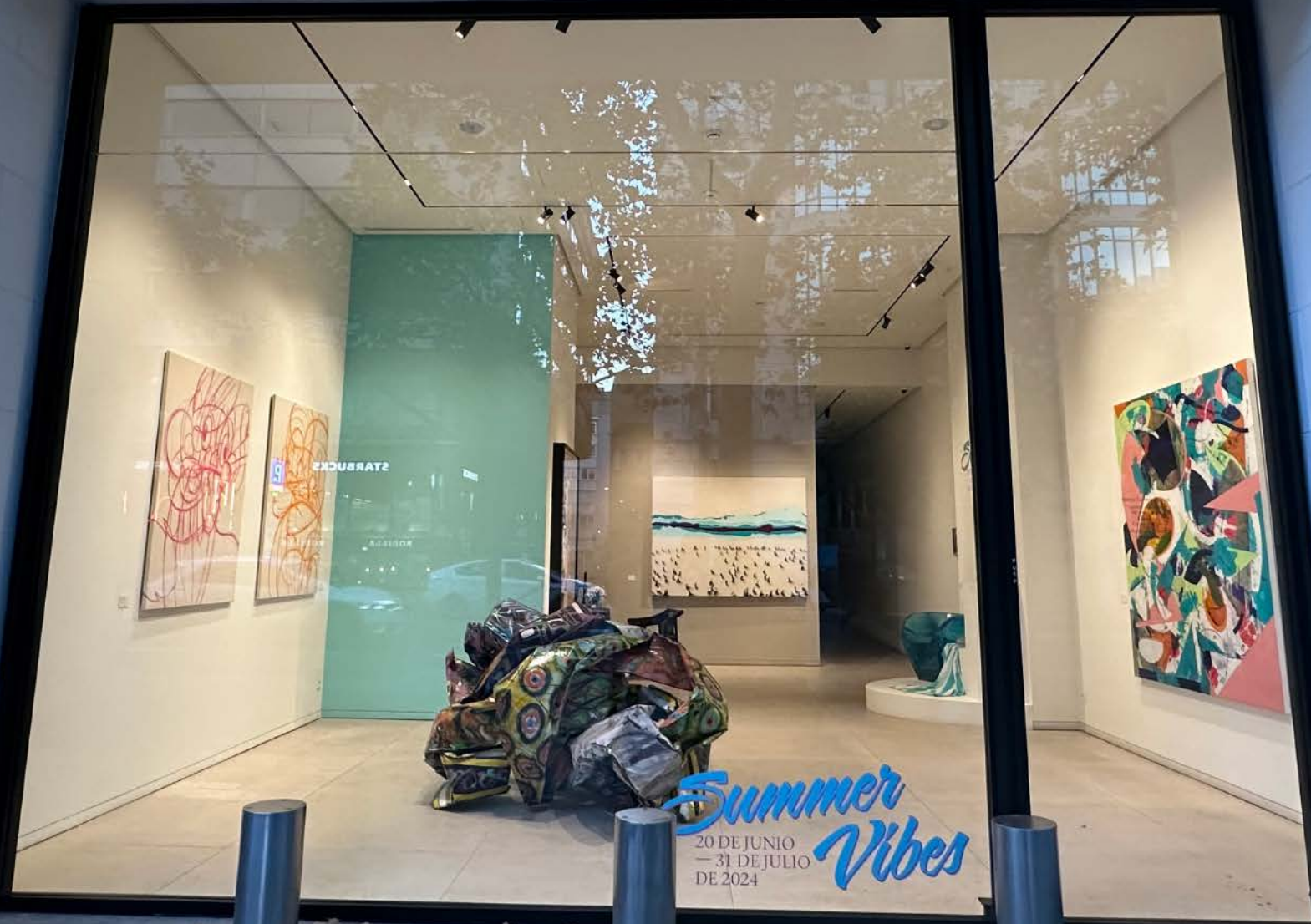

Summer Vibes
20 DE JUNIO
— 31 DE JULIO
DE 2024

OPERA GALLERY



ANY & CO.



MADRID

TIFFANY & CO.





CHANEL

CHANEL

CELINE

MADRID





*SANTA COLOMA
DE GRAMENET*





ESPLUGUES





CERDANYOLA





ULLASTRET





DOSRIUS



TORDERA





MADRID





TORREVIEJA





BADALONA

ADO





*FABRICA
BADALONA*





FABRICA
BADALONA





CONTACTO

TÉCNICO COMERCIAL

Ruben - ruben@adosa.es

+34 93 456 03 03 | +34 93 116 29 75

ASISTENCIA TÉCNICA

Enric - enric@adosa.es

+34 93 456 03 03 | +34 93 116 29 75



OFICINA Y FÁBRICA

C/ Acer, 37 al 43. Polígono Industrial Les Guixeres.
08915 Badalona.

+34 93 456 03 03

+34 93 116 29 75



ALMACÉN LOGÍSTICO

C/ Camí del Crist Polígono Industrial 2. Parcela 5.
08340 Vilassar de Mar.

+34 93 395 79 17